

## Replacement parts suitable for BYSTRONIC<sup>®</sup>

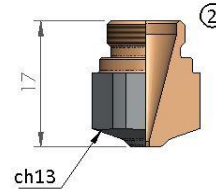

POS	LS. CODE	ORIGINAL CODE	DESCRIPTION	unit price	10 pack price
1	151001W	3-04277 HK08	BYSTRONIC <sup>®</sup> NOZZLE Ø 0.8 HD		
	151002W	3-01910 HK10	BYSTRONIC <sup>®</sup> NOZZLE Ø 1.0 HD		
	151003W	3-01911 HK12	BYSTRONIC <sup>®</sup> NOZZLE Ø 1.25 HD		
	151004W	3-01912 HK15	BYSTRONIC <sup>®</sup> NOZZLE Ø 1.5 HD		
	151005W	3-01913 HK17	BYSTRONIC <sup>®</sup> NOZZLE Ø 1.75 HD		
2	151001CW	3-04277 HK08	BYSTRONIC <sup>®</sup> NOZZLE Ø 0.8 HD CP		
	151002CW	3-01910 HK10	BYSTRONIC <sup>®</sup> NOZZLE Ø 1.0 HD CP		
	151003CW	3-01911 HK12	BYSTRONIC <sup>®</sup> NOZZLE Ø 1.25 HD CP		
	151004CW	3-01912 HK15	BYSTRONIC <sup>®</sup> NOZZLE Ø 1.5 HD CP		
	151005CW	3-01913 HK17	BYSTRONIC <sup>®</sup> NOZZLE Ø 1.75 HD CP		

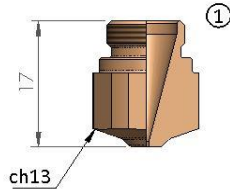
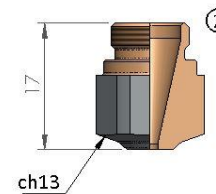
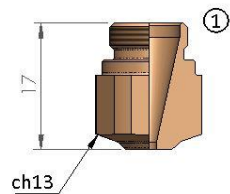

POS	LS. CODE	ORIGINAL CODE	DESCRIPTION	unit price	10 pack price
1	151006W	3-01914 HK20	BYSTRONIC <sup>®</sup> NOZZLE Ø 2.0 HD		
	151007W	3-03854 HK25	BYSTRONIC <sup>®</sup> NOZZLE Ø 2.5 HD		
	151008W	3-06112 HK30	BYSTRONIC <sup>®</sup> NOZZLE Ø 3.0 HD		
	151009W	HK35	BYSTRONIC <sup>®</sup> NOZZLE Ø 3.5 HD		
	151010W	HK40	BYSTRONIC <sup>®</sup> NOZZLE Ø 4.0 HD		
2	151006CW	3-01914 HK20	BYSTRONIC <sup>®</sup> NOZZLE Ø 2.0 HD CP		
	151007CW	3-03854 HK25	BYSTRONIC <sup>®</sup> NOZZLE Ø 2.5 HD CP		
	151008CW	3-06112 HK30	BYSTRONIC <sup>®</sup> NOZZLE Ø 3.0 HD CP		
	151009CW	HK35	BYSTRONIC <sup>®</sup> NOZZLE Ø 3.5 HD CP		
	151010CW	HK40	BYSTRONIC <sup>®</sup> NOZZLE Ø 4.0 HD CP		

## Replacement parts suitable for BYSTRONIC<sup>®</sup>

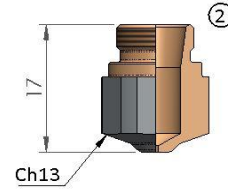
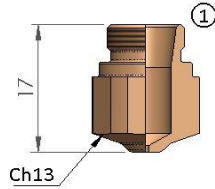

POS	LS. CODE	ORIGINAL CODE	DESCRIPTION	unit price	10 pack price
1	151014W	3-04273 K08	BYSTRONIC <sup>®</sup> NOZZLE Ø 0.8		
	151015W	3-01905 K10	BYSTRONIC <sup>®</sup> NOZZLE Ø 1.0		
	151016W	3-01906 K12	BYSTRONIC <sup>®</sup> NOZZLE Ø 1.25		
	151017W	3-01907 K15	BYSTRONIC <sup>®</sup> NOZZLE Ø 1.5		
	151018W	3-01908 K17	BYSTRONIC <sup>®</sup> NOZZLE Ø 1.75		
	151019W	3-01909 K20	BYSTRONIC <sup>®</sup> NOZZLE Ø 2.0		
	151020W	3-04274 K25	BYSTRONIC <sup>®</sup> NOZZLE Ø 2.5		
	151021W	3-04275 K30	BYSTRONIC <sup>®</sup> NOZZLE Ø 3.0		
2	151014CW	3-04273 K08	BYSTRONIC <sup>®</sup> NOZZLE Ø 0.8 CP		
	151015CW	3-01905 K10	BYSTRONIC <sup>®</sup> NOZZLE Ø 1.0 CP		
	151016CW	3-01906 K12	BYSTRONIC <sup>®</sup> NOZZLE Ø 1.25 CP		
	151017CW	3-01907 K15	BYSTRONIC <sup>®</sup> NOZZLE Ø 1.5 CP		
	151018CW	3-01908 K17	BYSTRONIC <sup>®</sup> NOZZLE Ø 1.75 CP		
	151019CW	3-01909 K20	BYSTRONIC <sup>®</sup> NOZZLE Ø 2.0 CP		
	151020CW	3-04274 K25	BYSTRONIC <sup>®</sup> NOZZLE Ø 2.5 CP		
	151021CW	3-04275 K30	BYSTRONIC <sup>®</sup> NOZZLE Ø 3.0 CP		

## Replacement parts suitable for BYSTRONIC<sup>®</sup>

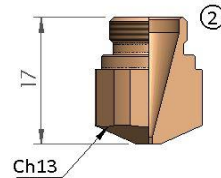
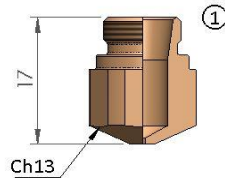

POS	LS. CODE	ORIGINAL CODE	DESCRIPTION	unit price	10 pack price
1	151023W	3-04273 K08	BYSTRONIC <sup>®</sup> NOZZLE Ø 0.8		
	151024W	3-01905 K10	BYSTRONIC <sup>®</sup> NOZZLE Ø 1.0		
	151025W	3-01906 K12	BYSTRONIC <sup>®</sup> NOZZLE Ø 1.25		
	151026W	3-01907 K15	BYSTRONIC <sup>®</sup> NOZZLE Ø 1.5		
	151027W	3-01908 K17	BYSTRONIC <sup>®</sup> NOZZLE Ø 1.75		
	151028W	3-01909 K20	BYSTRONIC <sup>®</sup> NOZZLE Ø 2.0		
2	151035W	3-01910 HK10	BYSTRONIC <sup>®</sup> NOZZLE Ø 1.0		
	151036W	3-01911 HK12	BYSTRONIC <sup>®</sup> NOZZLE Ø 1.25		
	151037W	3-01912 HK15	BYSTRONIC <sup>®</sup> NOZZLE Ø 1.5		
	151038W	3-01913 HK17	BYSTRONIC <sup>®</sup> NOZZLE Ø 1.75		
	151039W	3-01914 HK20	BYSTRONIC <sup>®</sup> NOZZLE Ø 2.0		

## Replacement parts suitable for BYSTRONIC<sup>®</sup>

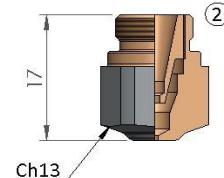
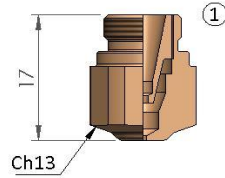

POS	LS. CODE	ORIGINAL CODE	DESCRIPTION	unit price	10 pack price
1	151040W	3-16058 NK10 - 15	BYSTRONIC <sup>®</sup> DOUBLE NOZZLE Ø 1.0		
	151041W	3-16059 NK12- 15	BYSTRONIC <sup>®</sup> DOUBLE NOZZLE Ø 1.25		
	151042W	3-16060 NK15- 15	BYSTRONIC <sup>®</sup> DOUBLE NOZZLE Ø 1.5		
	151043W	3-14317 NK17 - 15	BYSTRONIC <sup>®</sup> DOUBLE NOZZLE Ø 1.75		
	151044W	3-14318 NK20 - 15	BYSTRONIC <sup>®</sup> DOUBLE NOZZLE Ø 2.0		
	151045W	3-14319 NK25 - 15	BYSTRONIC <sup>®</sup> DOUBLE NOZZLE Ø 2.5		
	151046W	3-16256 NK25 - 20	BYSTRONIC <sup>®</sup> DOUBLE NOZZLE Ø 2.5		
	151047W	3-16061 NK30 - 17	BYSTRONIC <sup>®</sup> DOUBLE NOZZLE Ø 3.0		
	151048W	3-16257 NK30 - 20	BYSTRONIC <sup>®</sup> DOUBLE NOZZLE Ø 3.0		
	151049W	NK35-30	BYSTRONIC <sup>®</sup> DOUBLE NOZZLE Ø 3.5		
2	151040CW	3-16058 NK10 - 15	BYSTRONIC <sup>®</sup> DOUBLE NOZZLE Ø 1.0 CP		
	151041CW	3-16059 NK12- 15	BYSTRONIC <sup>®</sup> DOUBLE NOZZLE Ø 1.25 CP		
	151042CW	3-16060 NK15- 15	BYSTRONIC <sup>®</sup> DOUBLE NOZZLE Ø 1.5CP		
	151043CW	3-14317 NK17 - 15	BYSTRONIC <sup>®</sup> DOUBLE NOZZLE Ø 1.75 CP		
	151044CW	3-14318 NK20 - 15	BYSTRONIC <sup>®</sup> DOUBLE NOZZLE Ø 2.0 CP		
	151045CW	3-14319 NK25 - 15	BYSTRONIC <sup>®</sup> DOUBLE NOZZLE Ø 2.5 CP		
	151046CW	3-16256 NK25 - 20	BYSTRONIC <sup>®</sup> DOUBLE NOZZLE Ø 2.5 CP		
	151047CW	3-16061 NK30 - 17	BYSTRONIC <sup>®</sup> DOUBLE NOZZLE Ø 3.0 CP		
	151048CW	3-16257 NK30 - 20	BYSTRONIC <sup>®</sup> DOUBLE NOZZLE Ø 3.0 CP		
	151049CW	NK35-30	BYSTRONIC <sup>®</sup> DOUBLE NOZZLE Ø 3.5 CP		

## Replacement parts suitable for BYSTRONIC<sup>®</sup>

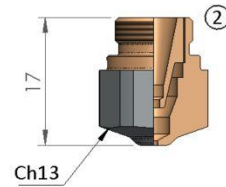
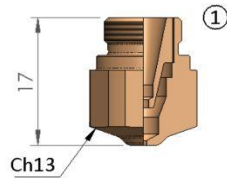

POS	LS. CODE	ORIGINAL CODE	DESCRIPTION	unit price	10 pack price
1	151030W	3-16058 NK10 - 15	BYSTRONIC <sup>®</sup> DOUBLE NOZZLE Ø 1.0		
	151031W	3-16059 NK12 - 15	BYSTRONIC <sup>®</sup> DOUBLE NOZZLE Ø 1.25		
	151032W	3-16060 NK15 - 15	BYSTRONIC <sup>®</sup> DOUBLE NOZZLE Ø 1.5		
	151033W	3-14317 NK17 - 15	BYSTRONIC <sup>®</sup> DOUBLE NOZZLE Ø 1.75		
2	151030CW	3-16058 NK10 - 15	BYSTRONIC <sup>®</sup> DOUBLE NOZZLE Ø 1.0 CP		
	151031CW	3-16059 NK12 - 15	BYSTRONIC <sup>®</sup> DOUBLE NOZZLE Ø 1.25 CP		
	151032CW	3-16060 NK15 - 15	BYSTRONIC <sup>®</sup> DOUBLE NOZZLE Ø 1.5 CP		
	151033CW	3-14317 NK17 - 15	BYSTRONIC <sup>®</sup> DOUBLE NOZZLE Ø 1.75 CP		

## Replacement parts suitable for BYSTRONIC<sup>®</sup>

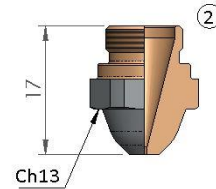
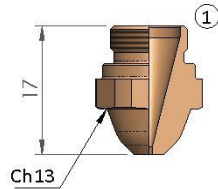

POS	LS. CODE	ORIGINAL CODE	DESCRIPTION	unit price	10 pack price
1	151055W	3-04275 H08	BYSTRONIC <sup>®</sup> NOZZLE Ø 0.8 HD		
	151056W	3-01899 H10	BYSTRONIC <sup>®</sup> NOZZLE Ø 1.0 HD		
	151057W	3-01900 H12	BYSTRONIC <sup>®</sup> NOZZLE Ø 1.25 HD		
	151058W	3-01901 H15	BYSTRONIC <sup>®</sup> NOZZLE Ø 1.5 HD		
	151059W	3-01902 H17	BYSTRONIC <sup>®</sup> NOZZLE Ø 1.75 HD		
	151060W	3-01903 H20	BYSTRONIC <sup>®</sup> NOZZLE Ø 2.0 HD		
	151061W	3-04276 H25	BYSTRONIC <sup>®</sup> NOZZLE Ø 2.5 HD		
	151062W	H30	BYSTRONIC <sup>®</sup> NOZZLE Ø 3.0 HD		
2	151055CW	3-04275 H08	BYSTRONIC <sup>®</sup> NOZZLE Ø 0.8 HD CP		
	151056CW	3-01899 H10	BYSTRONIC <sup>®</sup> NOZZLE Ø 1.0 HD CP		
	151057CW	3-01900 H12	BYSTRONIC <sup>®</sup> NOZZLE Ø 1.25 HD CP		
	151058CW	3-01901 H15	BYSTRONIC <sup>®</sup> NOZZLE Ø 1.5 HD CP		
	151059CW	3-01902 H17	BYSTRONIC <sup>®</sup> NOZZLE Ø 1.75 HD CP		
	151060CW	3-01903 H20	BYSTRONIC <sup>®</sup> NOZZLE Ø 2.0 HD CP		
	151061CW	3-04276 H25	BYSTRONIC <sup>®</sup> NOZZLE Ø 2.5 HD CP		
	151062CW	H30	BYSTRONIC <sup>®</sup> NOZZLE Ø 3.0 HD CP		

## Replacement parts suitable for BYSTRONIC<sup>®</sup>

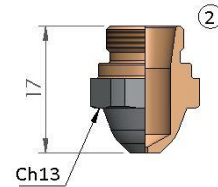
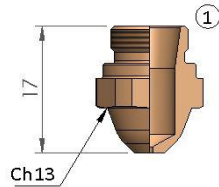

POS	LS. CODE	ORIGINAL CODE	DESCRIPTION	unit price	10 pack price
1	151065W	3-04271 08	BYSTRONIC <sup>®</sup> NOZZLE Ø 0.8		
	151066W	3-01894 10	BYSTRONIC <sup>®</sup> NOZZLE Ø 1.0		
	151067W	3-01895 12	BYSTRONIC <sup>®</sup> NOZZLE Ø 1.25		
	151068W	3-01896 15	BYSTRONIC <sup>®</sup> NOZZLE Ø 1.5		
	151069W	3-01897 17	BYSTRONIC <sup>®</sup> NOZZLE Ø 1.75		
	151070W	3-01898 20	BYSTRONIC <sup>®</sup> NOZZLE Ø 2.0		
	151071W	3-04272 25	BYSTRONIC <sup>®</sup> NOZZLE Ø 2.5		
2	151065CW	3-04271 08	BYSTRONIC <sup>®</sup> NOZZLE Ø 0.8 CP		
	151066CW	3-01894 10	BYSTRONIC <sup>®</sup> NOZZLE Ø 1.0 CP		
	151067CW	3-01895 12	BYSTRONIC <sup>®</sup> NOZZLE Ø 1.25 CP		
	151068CW	3-01896 15	BYSTRONIC <sup>®</sup> NOZZLE Ø 1.5 CP		
	151069CW	3-01897 17	BYSTRONIC <sup>®</sup> NOZZLE Ø 1.75 CP		
	151070CW	3-01898 20	BYSTRONIC <sup>®</sup> NOZZLE Ø 2.0 CP		
	151071CW	3-04272 25	BYSTRONIC <sup>®</sup> NOZZLE Ø 2.5 CP		

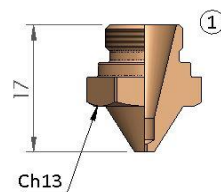

POS	LS. CODE	ORIGINAL CODE	DESCRIPTION	unit price	10 pack price
1	151085W	3-04271 08	BYSTRONIC <sup>®</sup> NOZZLE Ø 0.8		
	151086W	3-01894 10	BYSTRONIC <sup>®</sup> NOZZLE Ø 1.0		
	151087W	3-01895 12	BYSTRONIC <sup>®</sup> NOZZLE Ø 1.25		
	151088W	3-01896 15	BYSTRONIC <sup>®</sup> NOZZLE Ø 1.5		
	151089W	3-01897 17	BYSTRONIC <sup>®</sup> NOZZLE Ø 1.75		
	151090W	3-01898 20	BYSTRONIC <sup>®</sup> NOZZLE Ø 2.0		

## Replacement parts suitable for BYSTRONIC<sup>®</sup>

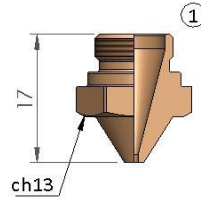

POS	LS. CODE	ORIGINAL CODE	DESCRIPTION	unit price	10 pack price
1	151092W	3-01899 H10	BYSTRONIC <sup>®</sup> DOUBLE NOZZLE Ø 1.0 HD		
	151093W	3-01900 H12	BYSTRONIC <sup>®</sup> DOUBLE NOZZLE Ø 1.25 HD		
	151094W	3-01901 H15	BYSTRONIC <sup>®</sup> DOUBLE NOZZLE Ø 1.5 HD		
	151095W	3-01902 H17	BYSTRONIC <sup>®</sup> DOUBLE NOZZLE Ø 1.75 HD		
	151096W	3-01903 H20	BYSTRONIC <sup>®</sup> DOUBLE NOZZLE Ø 2.0 HD		

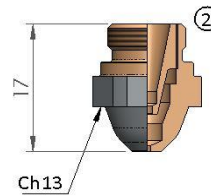
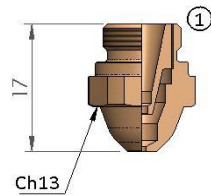

POS	LS. CODE	ORIGINAL CODE	DESCRIPTION	unit price	10 pack price
1	151075W	N10-15	BYSTRONIC <sup>®</sup> DOUBLE NOZZLE Ø 1.0		
	151076W	N12-15	BYSTRONIC <sup>®</sup> DOUBLE NOZZLE Ø 1.25		
	151077W	N15-15	BYSTRONIC <sup>®</sup> DOUBLE NOZZLE Ø 1.5		
	151078W	N17-15	BYSTRONIC <sup>®</sup> DOUBLE NOZZLE Ø 1.75		
	151079W	N20-15	BYSTRONIC <sup>®</sup> DOUBLE NOZZLE Ø 2.0		
	151080W	N25-15	BYSTRONIC <sup>®</sup> DOUBLE NOZZLE Ø 2.5		
	151081W	N25-20	BYSTRONIC <sup>®</sup> DOUBLE NOZZLE Ø 2.5		
	151082W	N30-17	BYSTRONIC <sup>®</sup> DOUBLE NOZZLE Ø 3.0		
	151083W	N30-20	BYSTRONIC <sup>®</sup> DOUBLE NOZZLE Ø 3.0		
2	151075CW	N10-15	BYSTRONIC <sup>®</sup> DOUBLE NOZZLE Ø 1.0 CP		
	151076CW	N12-15	BYSTRONIC <sup>®</sup> DOUBLE NOZZLE Ø 1.25 CP		
	151077CW	N15-15	BYSTRONIC <sup>®</sup> DOUBLE NOZZLE Ø 1.5 CP		
	151078CW	N17-15	BYSTRONIC <sup>®</sup> DOUBLE NOZZLE Ø 1.75 CP		
	151079CW	N20-15	BYSTRONIC <sup>®</sup> DOUBLE NOZZLE Ø 2.0 CP		
	151080CW	N25-15	BYSTRONIC <sup>®</sup> DOUBLE NOZZLE Ø 2.5 CP		
	151081CW	N25-20	BYSTRONIC <sup>®</sup> DOUBLE NOZZLE Ø 2.5 CP		
	151082CW	N30-17	BYSTRONIC <sup>®</sup> DOUBLE NOZZLE Ø 3.0 CP		
	151083CW	N30-20	BYSTRONIC <sup>®</sup> DOUBLE NOZZLE Ø 3.0 CP		



## Replacement parts suitable for BYSTRONIC<sup>®</sup>

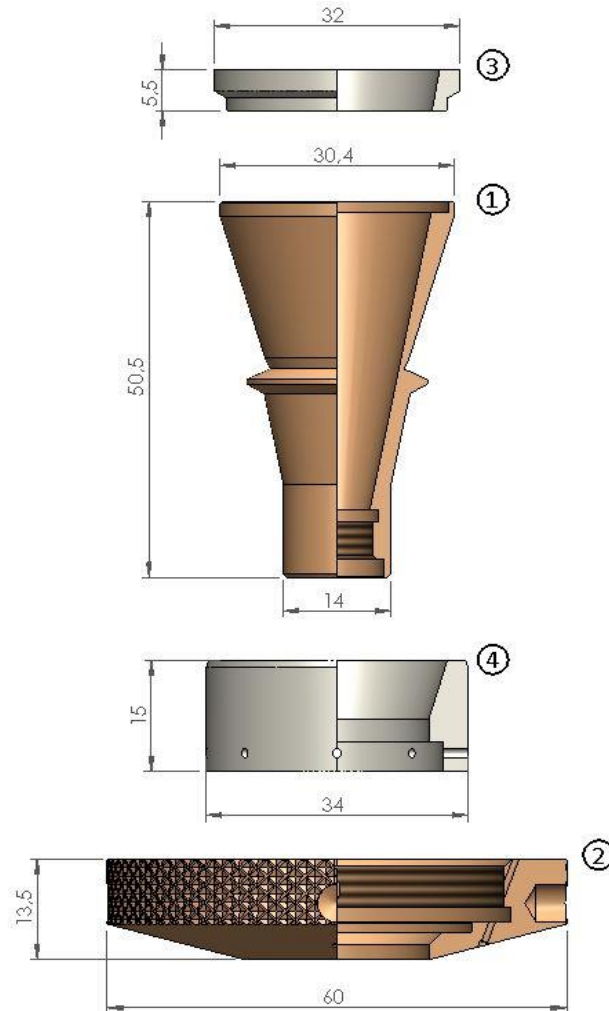

POS	LS. CODE	ORIGINAL CODE	DESCRIPTION	unit price	10 pack price
1	159020	2-10837	BYSTRONIC <sup>®</sup> NOZZLE BODY		
2	159025	3-13110	BYSTRONIC <sup>®</sup> COPPER SHIELD		
3	159022	3-13113	BYSTRONIC <sup>®</sup> INSULATING RING		
4	159024	3-13422	BYSTRONIC <sup>®</sup> INSULATING RING WITH HOLES		

## Replacement parts suitable for BYSTRONIC<sup>®</sup>

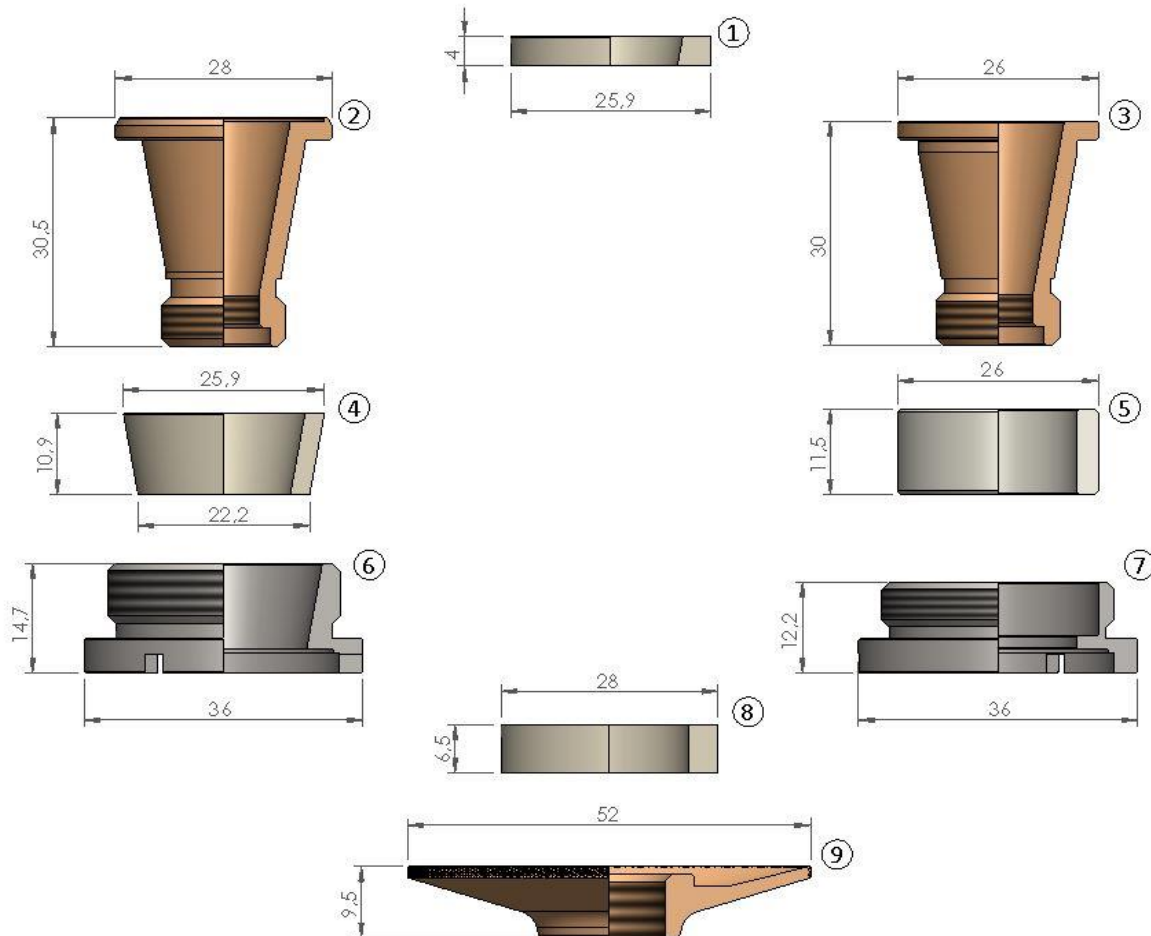

POS	LS. CODE	ORIGINAL CODE	DESCRIPTION	unit price	10 pack price
1	159004	4-01642	BYSTRONIC <sup>®</sup> CERAMIC INSULATING DISC		
	159005	4-01642	BYSTRONIC <sup>®</sup> CERAMIC INSULATING DISC NEW VERSION		
2	159001	2-08701	BYSTRONIC <sup>®</sup> NOZZLE BODY		
3	159002	10032930	BYSTRONIC <sup>®</sup> NOZZLE BODY		
4	159006	4-01959	BYSTRONIC <sup>®</sup> CERAMIC CONE		
	159007	4-01959	BYSTRONIC <sup>®</sup> CERAMIC CONE - NEW VERSION		
5	159010	10032838	BYSTRONIC <sup>®</sup> CERAMIC INSULATING RING		
6	159013	3-11071	BYSTRONIC <sup>®</sup> FASTENING NUT		
7	159014	10032839	BYSTRONIC <sup>®</sup> FASTENING NUT		
8	159008	4-09010	BYSTRONIC <sup>®</sup> CERAMIC INSULATING RING		
5	159017	2-08700	BYSTRONIC <sup>®</sup> SIGNBOARD		

## Replacement parts suitable for BYSTRONIC<sup>®</sup>

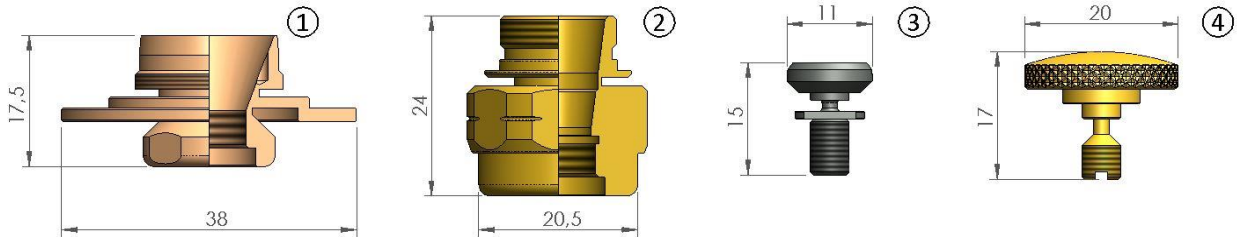

POS	LS. CODE	ORIGINAL CODE	DESCRIPTION	unit price	10 pack price
1	159035	10051133	BYSTRONIC <sup>®</sup> ADAPTER mSB		
2	159036	10064099	BYSTRONIC <sup>®</sup> NOZZLE BODY		
3	159029	3-09001	BYSTRONIC <sup>®</sup> SCREW FOR CROSS-JET		
4	159028	4-03136	BYSTRONIC <sup>®</sup> KNURLED SCREW - BRASS		

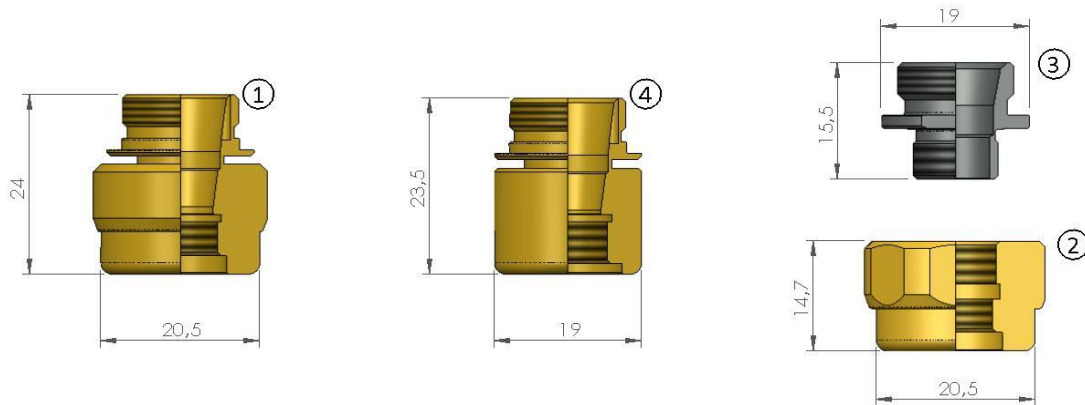

POS	LS. CODE	ORIGINAL CODE	DESCRIPTION	unit price	10 pack price
1	159037		BYSTRONIC <sup>®</sup> NOZZLE BODY		
2	159040	10071494	BYSTRONIC <sup>®</sup> NOZZLE BODY		
3	159041	10075057	BYSTRONIC <sup>®</sup> COUPLING		
4	159038		BISTRONIC <sup>®</sup> NOZZLE BODY		

## Replacement parts suitable for BYSTRONIC<sup>®</sup>



POS	LS. CODE	ORIGINAL CODE	DESCRIPTION	unit price	10 pack price
1	152001W	10048529 HK08	BYSTRONIC <sup>®</sup> NOZZLE Ø 0.8		
	152002W	10035266 HK10	BYSTRONIC <sup>®</sup> NOZZLE Ø 1.0		
	152003W	10035267 HK12	BYSTRONIC <sup>®</sup> NOZZLE Ø 1.2		
	152004W	10035268 HK15	BYSTRONIC <sup>®</sup> NOZZLE Ø 1.5		
	152005W	10035269 HK17	BYSTRONIC <sup>®</sup> NOZZLE Ø 1.75		
	152006W	10035270 HK20	BYSTRONIC <sup>®</sup> NOZZLE Ø 2.0		
	152007W	10035271, HK25	BYSTRONIC <sup>®</sup> NOZZLE Ø 2.5		
	152008W	10035272 HK30	BYSTRONIC <sup>®</sup> NOZZLE Ø 3.0		
	152009W	10049744 HK35	BYSTRONIC <sup>®</sup> NOZZLE Ø 3.5		
2	152015W	10049747 NK10-15	BYSTRONIC <sup>®</sup> DOUBLE NOZZLE Ø 1.0		
	152016W	10035275 NK12-15	BYSTRONIC <sup>®</sup> DOUBLE NOZZLE Ø 1.2		
	152017W	10035278 NK15-15	BYSTRONIC <sup>®</sup> DOUBLE NOZZLE Ø 1.5		
	152018W	10035290 NK17-15	BYSTRONIC <sup>®</sup> DOUBLE NOZZLE Ø 1.75		
	152019W	10035292 NK20-15	BYSTRONIC <sup>®</sup> DOUBLE NOZZLE Ø 2.0		
	152020W	10035294 NK25-15	BYSTRONIC <sup>®</sup> DOUBLE NOZZLE Ø 2.5		
	152021W	10035296 NK25-20	BYSTRONIC <sup>®</sup> DOUBLE NOZZLE Ø 2.5		
	152022W	10035298 NK30-17	BYSTRONIC <sup>®</sup> DOUBLE NOZZLE Ø 3.5		
	152023W	10035301 NK30-20	BYSTRONIC <sup>®</sup> DOUBLE NOZZLE Ø 3.0		
	152024W	10035303 NK35-30	BYSTRONIC <sup>®</sup> DOUBLE NOZZLE Ø 3.5		
	152025W	10068496 NK35-17	BYSTRONIC <sup>®</sup> DOUBLE NOZZLE Ø 3.5		
	152026W	10068496 NK40-17	BYSTRONIC <sup>®</sup> DOUBLE NOZZLE Ø 4.0		

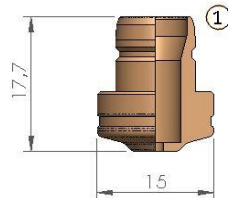

POS	LS. CODE	ORIGINAL CODE	DESCRIPTION	unit price	10 pack price
1	152030W	10039202	BYSTRONIC <sup>®</sup> NOZZLE Ø 2.0		

## Replacement parts suitable for BYSTRONIC<sup>®</sup>



POS	LS. CODE	ORIGINAL CODE	DESCRIPTION	unit price	10 pack price
1	152032CKW	10084700	BYSTRONIC <sup>®</sup> NOZZLE Ø2.0 F20 DW		
	152033CKW	10084701	BYSTRONIC <sup>®</sup> NOZZLE Ø2.5 F25 DW		
	152034CKW	10066333	BYSTRONIC <sup>®</sup> NOZZLE Ø3.0 F30 DW		
	152035CKW	10066332, 10090091	BYSTRONIC <sup>®</sup> NOZZLE Ø3.5 F35 DW		
2	152036CKW	10068494, 10090092	BYSTRONIC <sup>®</sup> NOZZLE Ø5.0 F50 DW		
	152037CKW	10066331	BYSTRONIC <sup>®</sup> NOZZLE Ø4.0 F40 DW		
	152038CKW	10066330	BYSTRONIC <sup>®</sup> NOZZLE Ø4.5 F45 DW		
	152039CKW	10086053	BYSTRONIC <sup>®</sup> NOZZLE Ø5.5 F55 DW		
	152040CKW	10086069	BYSTRONIC <sup>®</sup> NOZZLE Ø6.0 F60 DW		



POS	LS. CODE	ORIGINAL CODE	DESCRIPTION	unit price	10 pack price
1	153001CKW	10089806	BYSTRONIC <sup>®</sup> NOZZLE Ø2.0 F20		
	153002CKW	10089805	BYSTRONIC <sup>®</sup> NOZZLE Ø2.5 F25		
	153003CKW	10089803	BYSTRONIC <sup>®</sup> NOZZLE Ø3.0 F30		
	153004CKW	10090089	BYSTRONIC <sup>®</sup> NOZZLE Ø3.5 F35		
2	153005CKW	10089802	BYSTRONIC <sup>®</sup> NOZZLE Ø4.0 F40		
	153006CKW	10089800	BYSTRONIC <sup>®</sup> NOZZLE Ø4.5 F45		
	153007CKW	10090090	BYSTRONIC <sup>®</sup> NOZZLE Ø5.0 F50		
	153008CKW	10089799	BYSTRONIC <sup>®</sup> NOZZLE Ø5.5 F55		
	153009CKW	10089798	BYSTRONIC <sup>®</sup> NOZZLE Ø6.0 F60		

## Replacement parts suitable for BYSTRONIC<sup>®</sup>

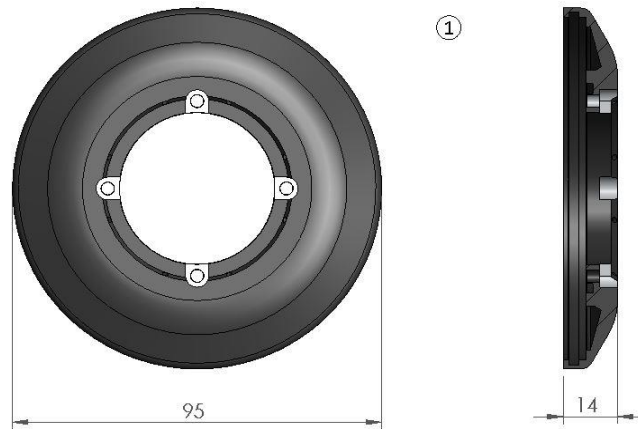

POS	LS. CODE	ORIGINAL CODE	DESCRIPTION	unit price	10 pack price
1	159050	2-03243 Kunde 24608	BYSTRONIC <sup>®</sup> FRONT PLATE		

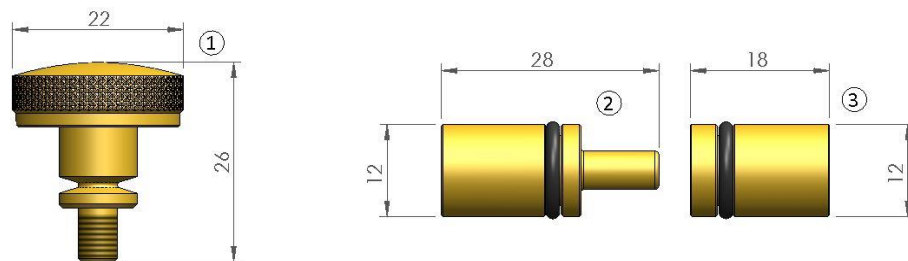

POS	LS. CODE	ORIGINAL CODE	DESCRIPTION	unit price	10 pack price
1	159031	4-04976	BYSTRONIC <sup>®</sup> KNURLED SCREW		
2	159045	7023207	BYSTRONIC <sup>®</sup> MALE WATER CONNECTOR		
3	159046	7023208	BYSTRONIC <sup>®</sup> FEMALE WATER CONNECTOR		
2+3	159047	7023207, 7023208	BYSTRONIC <sup>®</sup> WATER CONNECTOR MALE + FEMALE		