

## Replacement parts suitable for PRIMA INDUSTRIE<sup>®</sup>

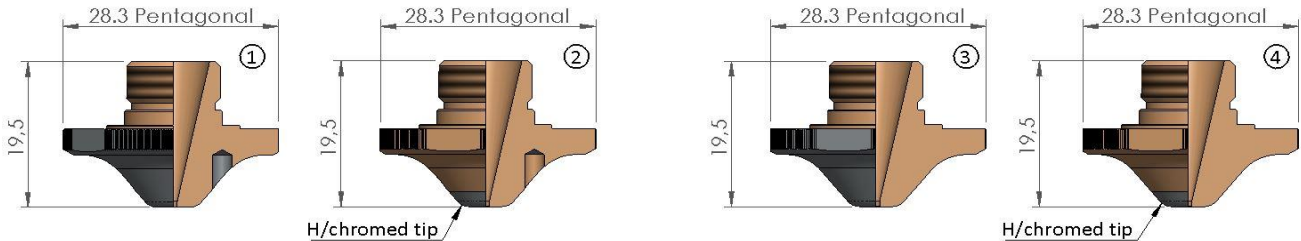

POS	LS. CODE	ORIGINAL CODE	DESCRIPTION	unit price	10 pack price
1	253014C	LW6.1G.660	PRIMA I. <sup>®</sup> NOZZLE PENT Ø 0.8 CP		
	253015C	LW6.1G.661	PRIMA I. <sup>®</sup> NOZZLE PENT Ø 1.0 CP		
	253016C	LW6.1G.662	PRIMA I. <sup>®</sup> NOZZLE PENT Ø 1.25 CP		
	253017C	LW6.1G.663	PRIMA I. <sup>®</sup> NOZZLE PENT Ø 1.5 CP		
	253018C	LW6.1G.664	PRIMA I. <sup>®</sup> NOZZLE PENT Ø 1.75 CP		
	253019C	LW6.1G.665	PRIMA I. <sup>®</sup> NOZZLE PENT Ø 2.0 CP		
	253020C	LW6.1G.667	PRIMA I. <sup>®</sup> NOZZLE PENT Ø 2.5 CP		
	253021C	LW6.1G.669	PRIMA I. <sup>®</sup> NOZZLE PENT Ø 3.0 CP		
	253022C	LW6.1G.670	PRIMA I. <sup>®</sup> NOZZLE PENT Ø 3.5 CP		
	253023C	LW6.1G.666	PRIMA I. <sup>®</sup> NOZZLE PENT Ø 2.25 CP		
	253024C	LW6.1G.668	PRIMA I. <sup>®</sup> NOZZLE PENT Ø 2.75 CP		
	2	253014CK	LW6.1G.660	PRIMA I. <sup>®</sup> NOZZLE PENT Ø 0.8 CP	
253015CK		LW6.1G.661	PRIMA I. <sup>®</sup> NOZZLE PENT Ø 1.0 CP		
253016CK		LW6.1G.662	PRIMA I. <sup>®</sup> NOZZLE PENT Ø 1.25 CP		
253017CK		LW6.1G.663	PRIMA I. <sup>®</sup> NOZZLE PENT Ø 1.5 CP		
253018CK		LW6.1G.664	PRIMA I. <sup>®</sup> NOZZLE PENT Ø 1.75 CP		
253019CK		LW6.1G.665	PRIMA I. <sup>®</sup> NOZZLE PENT Ø 2.0 CP		
253020CK		LW6.1G.667	PRIMA I. <sup>®</sup> NOZZLE PENT Ø 2.5 CP		
253021CK		LW6.1G.669	PRIMA I. <sup>®</sup> NOZZLE PENT Ø 3.0 CP		
253022CK		LW6.1G.670	PRIMA I. <sup>®</sup> NOZZLE PENT Ø 3.5 CP		
253023CK		LW6.1G.666	PRIMA I. <sup>®</sup> NOZZLE PENT Ø 2.25 CP		
253024CK	LW6.1G.668	PRIMA I. <sup>®</sup> NOZZLE PENT Ø 2.75 CP			
3	253025C	LW6.1G.103	PRIMA I. <sup>®</sup> NOZZLE PENT Ø 1.5 CP		
	253026C	LW6.1G.105	PRIMA I. <sup>®</sup> NOZZLE PENT Ø 2.0 CP		
	253027C	LW6.1G.107	PRIMA I. <sup>®</sup> NOZZLE PENT Ø 2.5 CP		
	253028C	LW6.1G.109	PRIMA I. <sup>®</sup> NOZZLE PENT Ø 3.0 CP		
4	253025CK	LW6.1G.103	PRIMA I. <sup>®</sup> NOZZLE PENT Ø 1.5 CP		
	253026CK	LW6.1G.105	PRIMA I. <sup>®</sup> NOZZLE PENT Ø 2.0 CP		
	253027CK	LW6.1G.107	PRIMA I. <sup>®</sup> NOZZLE PENT Ø 2.5 CP		
	253028CK	LW6.1G.109	PRIMA I. <sup>®</sup> NOZZLE PENT Ø 3.0 CP		

## Replacement parts suitable for PRIMA INDUSTRIE<sup>®</sup>

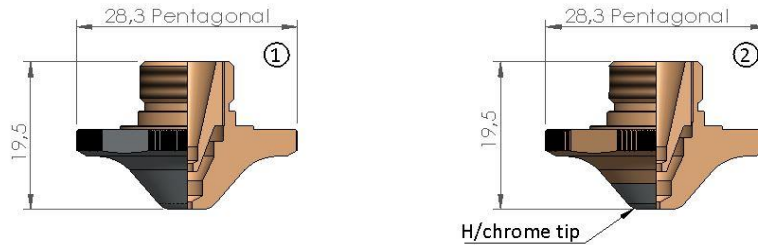

POS	LS. CODE	ORIGINAL CODE	DESCRIPTION	unit price	10 pack price
1	253033C	LW6.1G.302	PRIMA I. <sup>®</sup> DOUBLE NOZZLE PENT Ø 1.25 CP		
	253034C	LW6.1G.303	PRIMA I. <sup>®</sup> DOUBLE NOZZLE PENT Ø 1.5 CP		
	253035C	LW6.1G.304	PRIMA I. <sup>®</sup> DOUBLE NOZZLE PENT Ø 1.75 CP		
	253036C	LW6.1G.305	PRIMA I. <sup>®</sup> DOUBLE NOZZLE PENT Ø 2.0 CP		
	253037C	LW6.1G.307	PRIMA I. <sup>®</sup> DOUBLE NOZZLE PENT Ø 2.5 CP		
	253038C	LW6.1G.204	PRIMA I. <sup>®</sup> DOUBLE NOZZLE PENT Ø 2.5 CP		
	253039C	LW6.1G.309	PRIMA I. <sup>®</sup> DOUBLE NOZZLE PENT Ø 3.0 CP		
	253040C	LW6.1G.206	PRIMA I. <sup>®</sup> DOUBLE NOZZLE PENT Ø 3.0 CP		
	253041C	LW6.1G.207	PRIMA I. <sup>®</sup> DOUBLE NOZZLE PENT Ø 3.5 CP		
2	253033CK	LW6.1G.302	PRIMA I. <sup>®</sup> DOUBLE NOZZLE PENT Ø 1.25 CP		
	253034CK	LW6.1G.303	PRIMA I. <sup>®</sup> DOUBLE NOZZLE PENT Ø 1.5 CP		
	253035CK	LW6.1G.304	PRIMA I. <sup>®</sup> DOUBLE NOZZLE PENT Ø 1.75 CP		
	253036CK	LW6.1G.305	PRIMA I. <sup>®</sup> DOUBLE NOZZLE PENT Ø 2.0 CP		
	253037CK	LW6.1G.307	PRIMA I. <sup>®</sup> DOUBLE NOZZLE PENT Ø 2.5 CP		
	253038CK	LW6.1G.204	PRIMA I. <sup>®</sup> DOUBLE NOZZLE PENT Ø 2.5 CP		
	253039CK	LW6.1G.309	PRIMA I. <sup>®</sup> DOUBLE NOZZLE PENT Ø 3.0 CP		
	253040CK	LW6.1G.206	PRIMA I. <sup>®</sup> DOUBLE NOZZLE PENT Ø 3.0 CP		
	253041CK	LW6.1G.207	PRIMA I. <sup>®</sup> DOUBLE NOZZLE PENT Ø 3.5 CP		

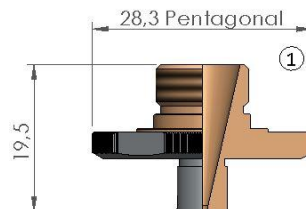

POS	LS. CODE	ORIGINAL CODE	DESCRIPTION	unit price	10 pack price
1	253045C	LW6.1G.699	PRIMA I. <sup>®</sup> NOZZLE PENT Ø 1.5 CP		
	253046C	LW6.1G.700	PRIMA I. <sup>®</sup> NOZZLE PENT Ø 2.0 CP		
	253047C	LW6.1G.701	PRIMA I. <sup>®</sup> NOZZLE PENT Ø 2.5 CP		
	253048C	LW6.1G.702	PRIMA I. <sup>®</sup> NOZZLE PENT Ø 3.0 CP		

## Replacement parts suitable for PRIMA INDUSTRIE<sup>®</sup>

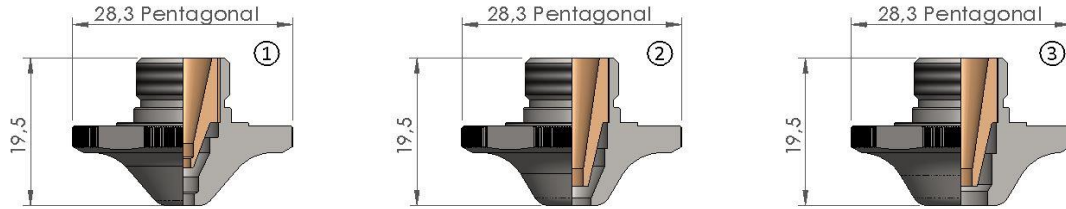

POS	LS. CODE	ORIGINAL CODE	DESCRIPTION	unit price	10 pack price
1	253050	LW6.1G.200	PRIMA I. <sup>®</sup> DOUBLE NOZZLE PENT Ø 3.0		
	253051	LW6.1G.201	PRIMA I. <sup>®</sup> DOUBLE NOZZLE PENT Ø 3.5		
	253052	LW6.1G.202	PRIMA I. <sup>®</sup> DOUBLE NOZZLE PENT Ø 4.0		
2	253053	LW6.1G.203	PRIMA I. <sup>®</sup> DOUBLE NOZZLE PENT Ø 5.0		
3	253054	LW6.1G.204	PRIMA I. <sup>®</sup> DOUBLE NOZZLE PENT Ø 7.0		

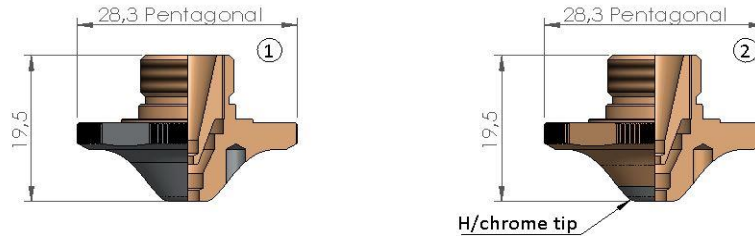

POS	LS. CODE	ORIGINAL CODE	DESCRIPTION	unit price	10 pack price
1	253060C	LW6.1G.680	PRIMA I. <sup>®</sup> DOUBLE NOZZLE PENT Ø 0.8 CP		
	253061C	LW6.1G.681	PRIMA I. <sup>®</sup> DOUBLE NOZZLE PENT Ø 1.0 CP		
	253062C	LW6.1G.682	PRIMA I. <sup>®</sup> DOUBLE NOZZLE PENT Ø 1.25 CP		
	253063C	LW6.1G.683	PRIMA I. <sup>®</sup> DOUBLE NOZZLE PENT Ø 1.5 CP		
	253064C	LW6.1G.684	PRIMA I. <sup>®</sup> DOUBLE NOZZLE PENT Ø 1.75 CP		
	253065C	LW6.1G.685	PRIMA I. <sup>®</sup> DOUBLE NOZZLE PENT Ø 2.0 CP		
	253066C	LW6.1G.686	PRIMA I. <sup>®</sup> DOUBLE NOZZLE PENT Ø 2.25 CP		
	253067C	LW6.1G.687	PRIMA I. <sup>®</sup> DOUBLE NOZZLE PENT Ø 2.5 CP		
	253068C	LW6.1G.688	PRIMA I. <sup>®</sup> DOUBLE NOZZLE PENT Ø 2.75 CP		
	253069C	LW6.1G.689	PRIMA I. <sup>®</sup> DOUBLE NOZZLE PENT Ø 3.0 CP		
2	253060CK	LW6.1G.680	PRIMA I. <sup>®</sup> DOUBLE NOZZLE PENT Ø 0.8 CP		
	253061CK	LW6.1G.681	PRIMA I. <sup>®</sup> DOUBLE NOZZLE PENT Ø 1.0 CP		
	253062CK	LW6.1G.682	PRIMA I. <sup>®</sup> DOUBLE NOZZLE PENT Ø 1.25 CP		
	253063CK	LW6.1G.683	PRIMA I. <sup>®</sup> DOUBLE NOZZLE PENT Ø 1.5 CP		
	253064CK	LW6.1G.684	PRIMA I. <sup>®</sup> DOUBLE NOZZLE PENT Ø 1.75 CP		
	253065CK	LW6.1G.685	PRIMA I. <sup>®</sup> DOUBLE NOZZLE PENT Ø 2.0 CP		
	253066CK	LW6.1G.686	PRIMA I. <sup>®</sup> DOUBLE NOZZLE PENT Ø 2.25 CP		
	253067CK	LW6.1G.687	PRIMA I. <sup>®</sup> DOUBLE NOZZLE PENT Ø 2.5 CP		
	253068CK	LW6.1G.688	PRIMA I. <sup>®</sup> DOUBLE NOZZLE PENT Ø 2.75 CP		
	253069CK	LW6.1G.689	PRIMA I. <sup>®</sup> DOUBLE NOZZLE PENT Ø 3.0 CP		

## Replacement parts suitable for PRIMA INDUSTRIE<sup>®</sup>

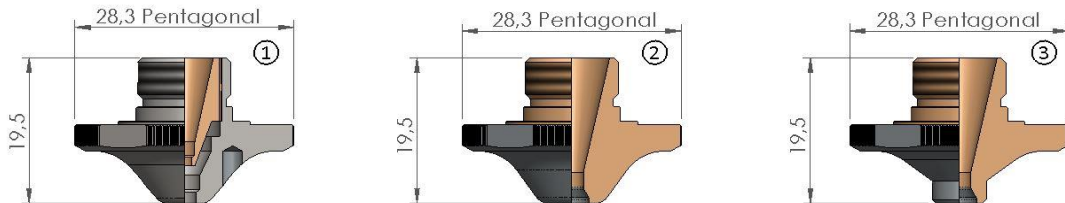

POS	LS. CODE	ORIGINAL CODE	DESCRIPTION	unit price	10 pack price
1	253074	LW6.1G.800	PRIMA I. <sup>®</sup> DOUBLE NOZZLE PENT Ø 3.0		
	253075	LW6.1G.801	PRIMA I. <sup>®</sup> DOUBLE NOZZLE PENT Ø 3.5		
	253076	LW6.1G.802	PRIMA I. <sup>®</sup> DOUBLE NOZZLE PENT Ø 4.0		
	253077	LW6.1G.803	PRIMA I. <sup>®</sup> DOUBLE NOZZLE PENT Ø 5.0		
	253078	LW6.1G.804	PRIMA I. <sup>®</sup> DOUBLE NOZZLE PENT Ø 7.0		
2	253080C	LW6.1G.522a	PRIMA I. <sup>®</sup> NOZZLE PENT Ø 3.0 CP		
3	253085C	LW6.1G.524	PRIMA I. <sup>®</sup> NOZZLE PENT Ø 3.0 CP		

---

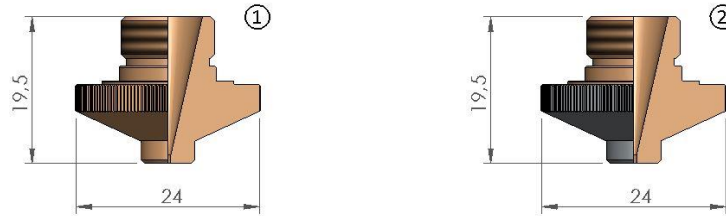

---

**Replacement parts suitable for PRIMA INDUSTRIE<sup>®</sup>**

POS	LS. CODE	ORIGINAL CODE	DESCRIPTION	unit price	10 pack price
1	251002		PRIMA I. <sup>®</sup> NOZZLE Ø 0.8		
	251002W		PRIMA I. <sup>®</sup> NOZZLE Ø 0.8		
	251003		PRIMA I. <sup>®</sup> NOZZLE Ø 1.0		
	251003W		PRIMA I. <sup>®</sup> NOZZLE Ø 1.0		
	251004		PRIMA I. <sup>®</sup> NOZZLE Ø 1.2		
	251004W		PRIMA I. <sup>®</sup> NOZZLE Ø 1.2		
	251005	LW6.1E.111	PRIMA I. <sup>®</sup> NOZZLE Ø 1.5		
	251005W	LW6.1E.111	PRIMA I. <sup>®</sup> NOZZLE Ø 1.5		
	251006	LW6.1E.112	PRIMA I. <sup>®</sup> NOZZLE Ø 2.0		
	251006W	LW6.1E.112	PRIMA I. <sup>®</sup> NOZZLE Ø 2.0		
	251007	LW6.1E.113	PRIMA I. <sup>®</sup> NOZZLE Ø 2.5		
	251007W	LW6.1E.113	PRIMA I. <sup>®</sup> NOZZLE Ø 2.5		
	251008	LW6.1E.114	PRIMA I. <sup>®</sup> NOZZLE Ø 3.0		
	251008W	LW6.1E.114	PRIMA I. <sup>®</sup> NOZZLE Ø 3.0		
2	251002C		PRIMA I. <sup>®</sup> NOZZLE Ø 0.8 CP		
	251002CW		PRIMA I. <sup>®</sup> NOZZLE Ø 0.8 CP		
	251003C		PRIMA I. <sup>®</sup> NOZZLE Ø 1.0 CP		
	251003CW		PRIMA I. <sup>®</sup> NOZZLE Ø 1.0 CP		
	251004C		PRIMA I. <sup>®</sup> NOZZLE Ø 1.2 CP		
	251004CW		PRIMA I. <sup>®</sup> NOZZLE Ø 1.2 CP		
	251005C	LW6.1E.111	PRIMA I. <sup>®</sup> NOZZLE Ø 1.5 CP		
	251005CW	LW6.1E.111	PRIMA I. <sup>®</sup> NOZZLE Ø 1.5 CP		
	251006C	LW6.1E.112	PRIMA I. <sup>®</sup> NOZZLE Ø 2.0 CP		
	251006CW	LW6.1E.112	PRIMA I. <sup>®</sup> NOZZLE Ø 2.0 CP		
	251007C	LW6.1E.113	PRIMA I. <sup>®</sup> NOZZLE Ø 2.5 CP		
	251007CW	LW6.1E.113	PRIMA I. <sup>®</sup> NOZZLE Ø 2.5 CP		
	251008C	LW6.1E.114	PRIMA I. <sup>®</sup> NOZZLE Ø 3.0 CP		
	251008CW	LW6.1E.114	PRIMA I. <sup>®</sup> NOZZLE Ø 3.0 CP		

---

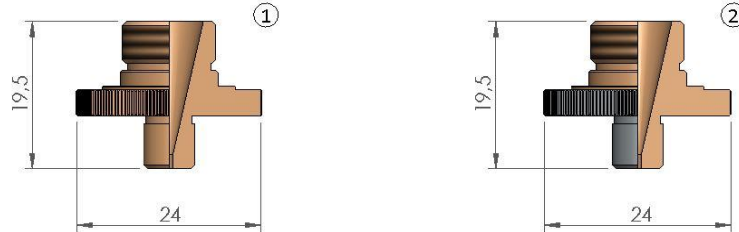

---

**Replacement parts suitable for PRIMA INDUSTRIE<sup>®</sup>**

POS	LS. CODE	ORIGINAL CODE	DESCRIPTION	unit price	10 pack price
1	251013		PRIMA I. <sup>®</sup> NOZZLE Ø 1.0		
	251013W		PRIMA I. <sup>®</sup> NOZZLE Ø 1.0		
	251014		PRIMA I. <sup>®</sup> NOZZLE Ø 1.2		
	251014W		PRIMA I. <sup>®</sup> NOZZLE Ø 1.2		
	251015	LW6.1G.500-LW6.1G.600	PRIMA I. <sup>®</sup> NOZZLE Ø 1.5		
	251015W	LW6.1G.500-LW6.1G.600	PRIMA I. <sup>®</sup> NOZZLE Ø 1.5		
	251016	LW6.1G.501-LW6.1G.601	PRIMA I. <sup>®</sup> NOZZLE Ø 2.0		
	251016W	LW6.1G.501-LW6.1G.601	PRIMA I. <sup>®</sup> NOZZLE Ø 2.0		
	251017	LW6.1G.502-LW6.1G.602	PRIMA I. <sup>®</sup> NOZZLE Ø 2.5		
	251017W	LW6.1G.502-LW6.1G.602	PRIMA I. <sup>®</sup> NOZZLE Ø 2.5		
	251018	LW6.1G.503-LW6.1G.603	PRIMA I. <sup>®</sup> NOZZLE Ø 3.0		
	251018W	LW6.1G.503-LW6.1G.603	PRIMA I. <sup>®</sup> NOZZLE Ø 3.0		
2	251013C		PRIMA I. <sup>®</sup> NOZZLE Ø 1.0 CP		
	251013CW		PRIMA I. <sup>®</sup> NOZZLE Ø 1.0 CP		
	251014C		PRIMA I. <sup>®</sup> NOZZLE Ø 1.2 CP		
	251014CW		PRIMA I. <sup>®</sup> NOZZLE Ø 1.2 CP		
	251015C	LW6.1G.500-LW6.1G.600	PRIMA I. <sup>®</sup> NOZZLE Ø 1.5 CP		
	251015CW	LW6.1G.500-LW6.1G.600	PRIMA I. <sup>®</sup> NOZZLE Ø 1.5 CP		
	251016C	LW6.1G.501-LW6.1G.601	PRIMA I. <sup>®</sup> NOZZLE Ø 2.0 CP		
	251016CW	LW6.1G.501-LW6.1G.601	PRIMA I. <sup>®</sup> NOZZLE Ø 2.0 CP		
	251017C	LW6.1G.502-LW6.1G.602	PRIMA I. <sup>®</sup> NOZZLE Ø 2.5 CP		
	251017CW	LW6.1G.502-LW6.1G.602	PRIMA I. <sup>®</sup> NOZZLE Ø 2.5 CP		
	251018C	LW6.1G.503-LW6.1G.603	PRIMA I. <sup>®</sup> NOZZLE Ø 3.0 CP		
	251018CW	LW6.1G.503-LW6.1G.603	PRIMA I. <sup>®</sup> NOZZLE Ø 3.0 CP		



## Replacement parts suitable for PRIMA INDUSTRIE<sup>®</sup>

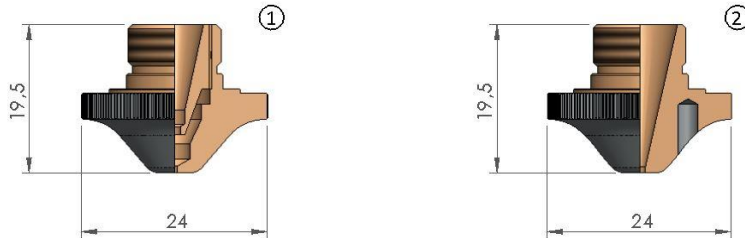

POS	LS. CODE	ORIGINAL CODE	DESCRIPTION	unit price	10 pack price
1	251022C	105.970.000.010	PRIMA I. <sup>®</sup> DOUBLE NOZZLE Ø 0.8 CP		
	251022CW	105.970.000.010	PRIMA I. <sup>®</sup> DOUBLE NOZZLE Ø 0.8 CP		
	251023C	105.970.000.003	PRIMA I. <sup>®</sup> DOUBLE NOZZLE Ø 1.0 CP		
	251023CW	105.970.000.003	PRIMA I. <sup>®</sup> DOUBLE NOZZLE Ø 1.0 CP		
	251024C	105.970.000.008	PRIMA I. <sup>®</sup> DOUBLE NOZZLE Ø 1.25 CP		
	251024CW	105.970.000.008	PRIMA I. <sup>®</sup> DOUBLE NOZZLE Ø 1.25 CP		
	251025C	105.970.000.004	PRIMA I. <sup>®</sup> DOUBLE NOZZLE Ø 1.5 CP		
	251025CW	105.970.000.004	PRIMA I. <sup>®</sup> DOUBLE NOZZLE Ø 1.5 CP		
	251026C	105.970.000.009	PRIMA I. <sup>®</sup> DOUBLE NOZZLE Ø 1.75 CP		
	251026CW	105.970.000.009	PRIMA I. <sup>®</sup> DOUBLE NOZZLE Ø 1.75 CP		
	251027C	105.970.000.005	PRIMA I. <sup>®</sup> DOUBLE NOZZLE Ø 2.0 CP		
	251027CW	105.970.000.005	PRIMA I. <sup>®</sup> DOUBLE NOZZLE Ø 2.0 CP		
	251028C	105.970.000.006	PRIMA I. <sup>®</sup> DOUBLE NOZZLE Ø 2.5 CP		
	251028CW	105.970.000.006	PRIMA I. <sup>®</sup> DOUBLE NOZZLE Ø 2.5 CP		
251029C	105.970.000.007	PRIMA I. <sup>®</sup> DOUBLE NOZZLE Ø 3.0 CP			
251029CW	105.970.000.007	PRIMA I. <sup>®</sup> DOUBLE NOZZLE Ø 3.0 CP			
2	253005C	LW6.1G.604	PRIMA I. <sup>®</sup> NOZZLE Ø 1.5 CP		
	253005CW	LW6.1G.604	PRIMA I. <sup>®</sup> NOZZLE Ø 1.5 CP		
	253006C		PRIMA I. <sup>®</sup> NOZZLE Ø 1.75 CP		
	253006CW		PRIMA I. <sup>®</sup> NOZZLE Ø 1.75 CP		
	253007C	LW6.1G.605	PRIMA I. <sup>®</sup> NOZZLE Ø 2.0 CP		
	253007CW	LW6.1G.605	PRIMA I. <sup>®</sup> NOZZLE Ø 2.0 CP		
	253008C	LW6.1G.606	PRIMA I. <sup>®</sup> NOZZLE Ø 2.5 CP		
	253008CW	LW6.1G.606	PRIMA I. <sup>®</sup> NOZZLE Ø 2.5 CP		
	253009C	LW6.1G.607	PRIMA I. <sup>®</sup> NOZZLE Ø 3.0 CP		
253009CW	LW6.1G.607	PRIMA I. <sup>®</sup> NOZZLE Ø 3.0 CP			

---

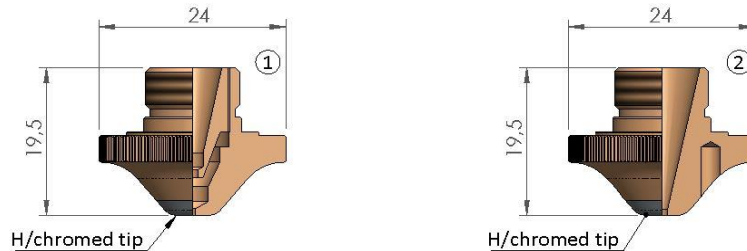

---

**Replacement parts suitable for PRIMA INDUSTRIE<sup>®</sup>**

POS	LS. CODE	ORIGINAL CODE	DESCRIPTION	unit price	10 pack price
1	251022CK	105.970.000.010	PRIMA I. <sup>®</sup> DOUBLE NOZZLE Ø 0.8 CP		
	251022CKW	105.970.000.010	PRIMA I. <sup>®</sup> DOUBLE NOZZLE Ø 0.8 CP		
	251023CK	105.970.000.003	PRIMA I. <sup>®</sup> DOUBLE NOZZLE Ø 1.0 CP		
	251023CKW	105.970.000.003	PRIMA I. <sup>®</sup> DOUBLE NOZZLE Ø 1.0 CP		
	251024CK	105.970.000.008	PRIMA I. <sup>®</sup> DOUBLE NOZZLE Ø 1.25 CP		
	251024CKW	105.970.000.008	PRIMA I. <sup>®</sup> DOUBLE NOZZLE Ø 1.25 CP		
	251025CK	105.970.000.004	PRIMA I. <sup>®</sup> DOUBLE NOZZLE Ø 1.5 CP		
	251025CKW	105.970.000.004	PRIMA I. <sup>®</sup> DOUBLE NOZZLE Ø 1.5 CP		
	251026CK	105.970.000.009	PRIMA I. <sup>®</sup> DOUBLE NOZZLE Ø 1.75 CP		
	251026CKW	105.970.000.009	PRIMA I. <sup>®</sup> DOUBLE NOZZLE Ø 1.75 CP		
	251027CK	105.970.000.005	PRIMA I. <sup>®</sup> DOUBLE NOZZLE Ø 2.0 CP		
	251027CKW	105.970.000.005	PRIMA I. <sup>®</sup> DOUBLE NOZZLE Ø 2.0 CP		
	251028CK	105.970.000.006	PRIMA I. <sup>®</sup> DOUBLE NOZZLE Ø 2.5 CP		
	251028CKW	105.970.000.006	PRIMA I. <sup>®</sup> DOUBLE NOZZLE Ø 2.5 CP		
	251029CK	105.970.000.007	PRIMA I. <sup>®</sup> DOUBLE NOZZLE Ø 3.0 CP		
	251029CKW	105.970.000.007	PRIMA I. <sup>®</sup> DOUBLE NOZZLE Ø 3.0 CP		
2	253005CK	LW6.1G.604	PRIMA I. <sup>®</sup> NOZZLE Ø 1.5 CP		
	253005CKW	LW6.1G.604	PRIMA I. <sup>®</sup> NOZZLE Ø 1.5 CP		
	253006CK		PRIMA I. <sup>®</sup> NOZZLE Ø 1.75 CP		
	253006CKW		PRIMA I. <sup>®</sup> NOZZLE Ø 1.75 CP		
	253007CK	LW6.1G.605	PRIMA I. <sup>®</sup> NOZZLE Ø 2.0 CP		
	253007CKW	LW6.1G.605	PRIMA I. <sup>®</sup> NOZZLE Ø 2.0 CP		
	253008CK	LW6.1G.606	PRIMA I. <sup>®</sup> NOZZLE Ø 2.5 CP		
	253008CKW	LW6.1G.606	PRIMA I. <sup>®</sup> NOZZLE Ø 2.5 CP		
	253009CK	LW6.1G.607	PRIMA I. <sup>®</sup> NOZZLE Ø 3.0 CP		
	253009CKW	LW6.1G.607	PRIMA I. <sup>®</sup> NOZZLE Ø 3.0 CP		



## Replacement parts suitable for PRIMA INDUSTRIE<sup>®</sup>

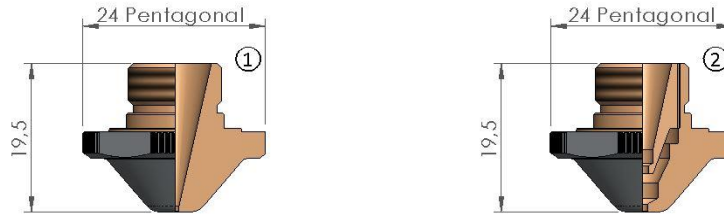

POS	LS. CODE	ORIGINAL CODE	DESCRIPTION	unit price	10 pack price
1	254003C	LW6.1G.633	PRIMA I. <sup>®</sup> NOZZLE PENT Ø 1.5 CP		
	254003CW	LW6.1G.633	PRIMA I. <sup>®</sup> NOZZLE PENT Ø 1.5 CP		
	254004C	LW6.1G.635	PRIMA I. <sup>®</sup> NOZZLE PENT Ø 2.0 CP		
	254004CW	LW6.1G.635	PRIMA I. <sup>®</sup> NOZZLE PENT Ø 2.0 CP		
	254005C	LW6.1G.637	PRIMA I. <sup>®</sup> NOZZLE PENT Ø 2.5 CP		
	254005CW	LW6.1G.637	PRIMA I. <sup>®</sup> NOZZLE PENT Ø 2.5 CP		
2	254013C	LW6.1G.643	PRIMA I. <sup>®</sup> DOUBLE NOZZLE PENT Ø 1.5 CP		
	254013CW	LW6.1G.643	PRIMA I. <sup>®</sup> DOUBLE NOZZLE PENT Ø 1.5 CP		
	254014C	LW6.1G.645	PRIMA I. <sup>®</sup> DOUBLE NOZZLE PENT Ø 2.0 CP		
	254014CW	LW6.1G.645	PRIMA I. <sup>®</sup> DOUBLE NOZZLE PENT Ø 2.0 CP		
	254015C	LW6.1G.647	PRIMA I. <sup>®</sup> DOUBLE NOZZLE PENT Ø 2.5 CP		
	254015CW	LW6.1G.647	PRIMA I. <sup>®</sup> DOUBLE NOZZLE PENT Ø 2.5 CP		

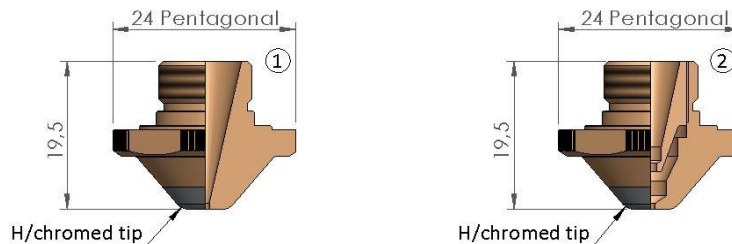

POS	LS. CODE	ORIGINAL CODE	DESCRIPTION	unit price	10 pack price
1	254003CK	LW6.1G.633	PRIMA I. <sup>®</sup> NOZZLE PENT Ø 1.5 CP		
	254003CKW	LW6.1G.633	PRIMA I. <sup>®</sup> NOZZLE PENT Ø 1.5 CP		
	254004CK	LW6.1G.635	PRIMA I. <sup>®</sup> NOZZLE PENT Ø 2.0 CP		
	254004CKW	LW6.1G.635	PRIMA I. <sup>®</sup> NOZZLE PENT Ø 2.0 CP		
	254005CK	LW6.1G.637	PRIMA I. <sup>®</sup> NOZZLE PENT Ø 2.5 CP		
	254005CKW	LW6.1G.637	PRIMA I. <sup>®</sup> NOZZLE PENT Ø 2.5 CP		
2	254013CK	LW6.1G.643	PRIMA I. <sup>®</sup> DOUBLE NOZZLE PENT Ø 1.5 CP		
	254013CKW	LW6.1G.643	PRIMA I. <sup>®</sup> DOUBLE NOZZLE PENT Ø 1.5 CP		
	254014CK	LW6.1G.645	PRIMA I. <sup>®</sup> DOUBLE NOZZLE PENT Ø 2.0 CP		
	254014CKW	LW6.1G.645	PRIMA I. <sup>®</sup> DOUBLE NOZZLE PENT Ø 2.0 CP		
	254015CK	LW6.1G.647	PRIMA I. <sup>®</sup> DOUBLE NOZZLE PENT Ø 2.5 CP		
	254015CKW	LW6.1G.647	PRIMA I. <sup>®</sup> DOUBLE NOZZLE PENT Ø 2.5 CP		

## Replacement parts suitable for PRIMA INDUSTRIE<sup>®</sup>

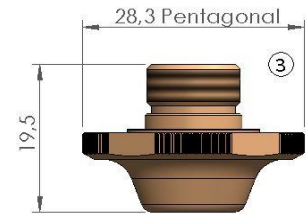
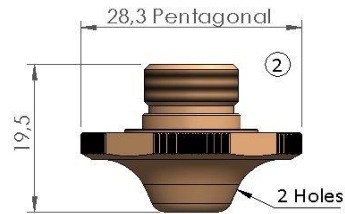
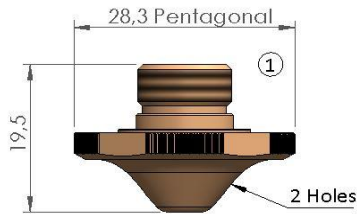

POS	LS. CODE	ORIGINAL CODE	DESCRIPTION	unit price	10 pack price
1	256001		PRIMA I. <sup>®</sup> DOUBLE NOZZLE PENT Ø 2.5 - SS		
	256002		PRIMA I. <sup>®</sup> DOUBLE NOZZLE PENT Ø 3.0 - SS		
	256003		PRIMA I. <sup>®</sup> DOUBLE NOZZLE PENT Ø 4.0 - SS		
2	256004		PRIMA I. <sup>®</sup> DOUBLE NOZZLE PENT Ø 6.0 - SS		
3	256005		PRIMA I. <sup>®</sup> DOUBLE NOZZLE PENT Ø 10.0 - SS		

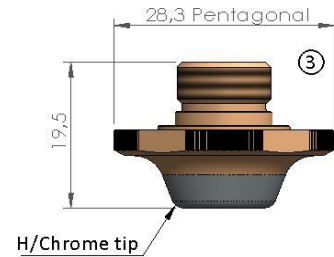
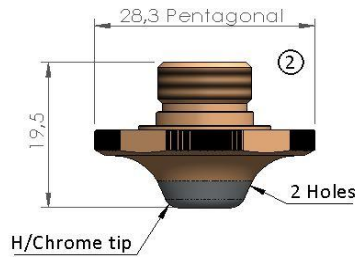
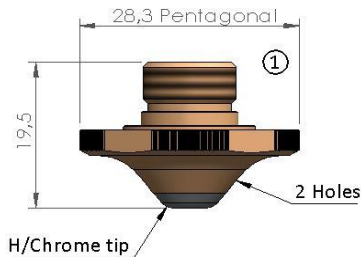

POS	LS. CODE	ORIGINAL CODE	DESCRIPTION	unit price	10 pack price
1	256001CK		PRIMA I. <sup>®</sup> DOUBLE NOZZLE PENT Ø 2.5 CP - SS		
	256002CK		PRIMA I. <sup>®</sup> DOUBLE NOZZLE PENT Ø 3.0 CP - SS		
	256003CK		PRIMA I. <sup>®</sup> DOUBLE NOZZLE PENT Ø 4.0 CP - SS		
2	256004CK		PRIMA I. <sup>®</sup> DOUBLE NOZZLE PENT Ø 6.0 CP - SS		
3	256005CK		PRIMA I. <sup>®</sup> DOUBLE NOZZLE PENT Ø 10.0 CP - SS		

---

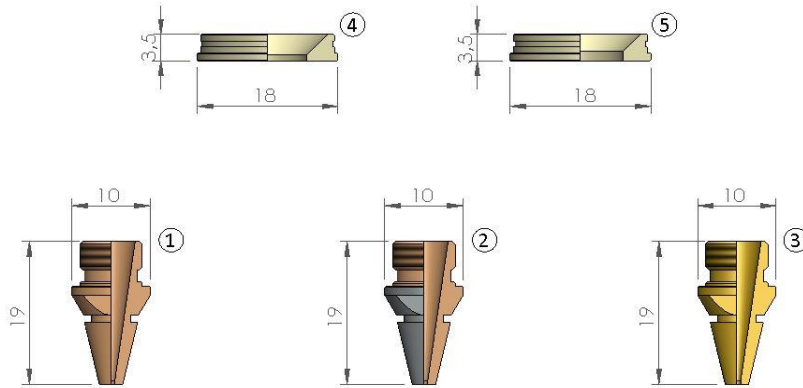

---

 Replacement parts suitable for PRIMA INDUSTRIE<sup>®</sup>

POS	LS. CODE	ORIGINAL CODE	DESCRIPTION	unit price	10 pack price
1	252011W		PRIMA I. <sup>®</sup> NOZZLE Ø 1.0 CONICAL		
	252012W		PRIMA I. <sup>®</sup> NOZZLE Ø 1.2 CONICAL		
	252013W		PRIMA I. <sup>®</sup> NOZZLE Ø 1.5 CONICAL		
	252014W		PRIMA I. <sup>®</sup> NOZZLE Ø 1.7 CONICAL		
	252015W		PRIMA I. <sup>®</sup> NOZZLE Ø 2.0 CONICAL		
	252016W		PRIMA I. <sup>®</sup> NOZZLE Ø 2.5 CONICAL		
	252017W		PRIMA I. <sup>®</sup> NOZZLE Ø 3.0 CONICAL		
2	252011CW		PRIMA I. <sup>®</sup> NOZZLE Ø 1.0 CP		
	252012CW		PRIMA I. <sup>®</sup> NOZZLE Ø 1.2 CP		
	252013CW	485.73.431	PRIMA I. <sup>®</sup> NOZZLE Ø 1.5 CP		
	252014CW		PRIMA I. <sup>®</sup> NOZZLE Ø 1.7 CP		
	252015CW	485.73.433	PRIMA I. <sup>®</sup> NOZZLE Ø 2.0 CP		
	252016CW		PRIMA I. <sup>®</sup> NOZZLE Ø 2.5 CP		
	252017CW		PRIMA I. <sup>®</sup> NOZZLE Ø 3.0 CP		
3	252043W	485.73.331	PRIMA I. <sup>®</sup> NOZZLE Ø 1.5 BRASS		
	252045W	485.73.333	PRIMA I. <sup>®</sup> NOZZLE Ø 2.0 BRASS		
	252046W	485.73.334	PRIMA I. <sup>®</sup> NOZZLE Ø 2.5 BRASS		
4	259001	480.73.107	PRIMA I. <sup>®</sup> INSULATING RING-PLASTIC - HEAD 5" - ID 10		
5	259002		PRIMA I. <sup>®</sup> INSULATING RING-PLASTIC - HEAD 7.5" - ID 11		

---

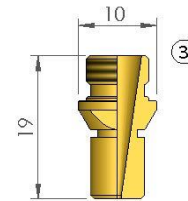
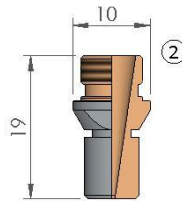
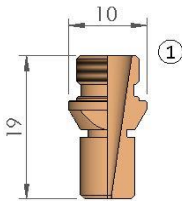

---

**Replacement parts suitable for PRIMA INDUSTRIE<sup>®</sup>**

POS	LS. CODE	ORIGINAL CODE	DESCRIPTION	unit price	10 pack price
1	252001W		PRIMA I. <sup>®</sup> NOZZLE Ø 1.0		
	252002W		PRIMA I. <sup>®</sup> NOZZLE Ø 1.2		
	252003W		PRIMA I. <sup>®</sup> NOZZLE Ø 1.5		
	252004W		PRIMA I. <sup>®</sup> NOZZLE Ø 1.7		
	252005W		PRIMA I. <sup>®</sup> NOZZLE Ø 2.0		
	252006W		PRIMA I. <sup>®</sup> NOZZLE Ø 2.5		
	252007W		PRIMA I. <sup>®</sup> NOZZLE Ø 3.0		
2	252001CW		PRIMA I. <sup>®</sup> NOZZLE Ø 1.0 CP		
	252002CW		PRIMA I. <sup>®</sup> NOZZLE Ø 1.2 CP		
	252003CW	485.73.421	PRIMA I. <sup>®</sup> NOZZLE Ø 1.5 CP		
	252004CW		PRIMA I. <sup>®</sup> NOZZLE Ø 1.7 CP		
	252005CW	485.73.422	PRIMA I. <sup>®</sup> NOZZLE Ø 2.0 CP		
	252006CW	485.73.423	PRIMA I. <sup>®</sup> NOZZLE Ø 2.5 CP		
	252007CW	485.73.424	PRIMA I. <sup>®</sup> NOZZLE Ø 3.0 CP		
3	252031W		PRIMA I. <sup>®</sup> NOZZLE Ø 1.0 BRASS		
	252033W	485.73.321	PRIMA I. <sup>®</sup> NOZZLE Ø 1.5 BRASS		
	252035W	485.73.322	PRIMA I. <sup>®</sup> NOZZLE Ø 2.0 BRASS		
	252036W	485.73.323	PRIMA I. <sup>®</sup> NOZZLE Ø 2.5 BRASS		
	252037W	485.73.324	PRIMA I. <sup>®</sup> NOZZLE Ø 3.0 BRASS		

## Replacement parts suitable for PRIMA INDUSTRIE<sup>®</sup>

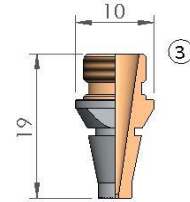
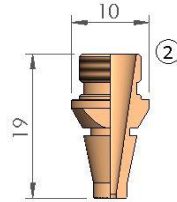
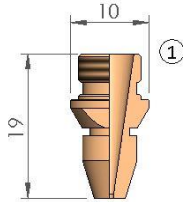

POS	LS. CODE	ORIGINAL CODE	DESCRIPTION	unit price	10 pack price
1	252061W		PRIMA I. <sup>®</sup> NOZZLE Ø 1.0		
	252062W		PRIMA I. <sup>®</sup> NOZZLE Ø 1.2		
	252063W		PRIMA I. <sup>®</sup> NOZZLE Ø 1.5		
	252064W		PRIMA I. <sup>®</sup> NOZZLE Ø 1.7		
	252065W		PRIMA I. <sup>®</sup> NOZZLE Ø 2.0		
	252066W		PRIMA I. <sup>®</sup> NOZZLE Ø 2.5		
	252067W		PRIMA I. <sup>®</sup> NOZZLE Ø 3.0		
2	252023W		PRIMA I. <sup>®</sup> NOZZLE Ø 1.5		
	252024W		PRIMA I. <sup>®</sup> NOZZLE Ø 2.0		
	252025W		PRIMA I. <sup>®</sup> NOZZLE Ø 2.5		
	252026W		PRIMA I. <sup>®</sup> NOZZLE Ø 3.0		
3	252023CW	485.73.451	PRIMA I. <sup>®</sup> NOZZLE Ø 1.5 CP		
	252024CW	485.73.452	PRIMA I. <sup>®</sup> NOZZLE Ø 2.0 CP		
	252025CW	485.73.453	PRIMA I. <sup>®</sup> NOZZLE Ø 2.5 CP		
	252026CW		PRIMA I. <sup>®</sup> NOZZLE Ø 3.0 CP		

---

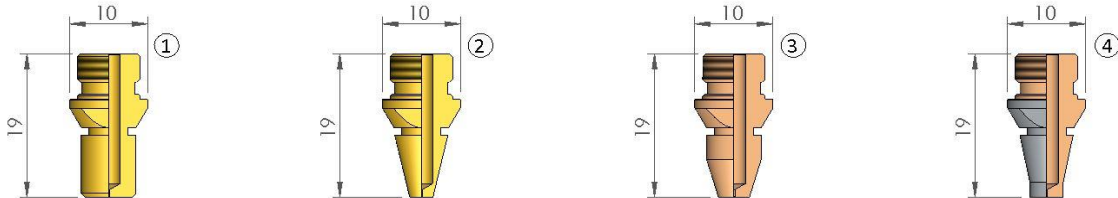

---

**Replacement parts suitable for PRIMA INDUSTRIE<sup>®</sup>**

POS	LS. CODE	ORIGINAL CODE	DESCRIPTION	unit price	10 pack price
1	252070W		PRIMA I. <sup>®</sup> NOZZLE Ø 0.3 BRASS		
2	252071W		PRIMA I. <sup>®</sup> NOZZLE Ø 0.3 BRASS		
3	252072W		PRIMA I. <sup>®</sup> NOZZLE Ø 0.3		
4	252073CW	485.73.455	PRIMA I. <sup>®</sup> NOZZLE Ø 0.3 CP		

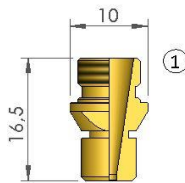

POS	LS. CODE	ORIGINAL CODE	DESCRIPTION	unit price	10 pack price
1	252051W	490.1N.301	PRIMA I. <sup>®</sup> NOZZLE Ø 2.0 BRASS		
	252052W	490.1N.302	PRIMA I. <sup>®</sup> NOZZLE Ø 2.5 BRASS		
	252053W		PRIMA I. <sup>®</sup> NOZZLE Ø 3.0 BRASS		